

- INSTRUCTION MANUAL -

NEU TABLE



DESIGN BY HAY

HAY

- PARTS -

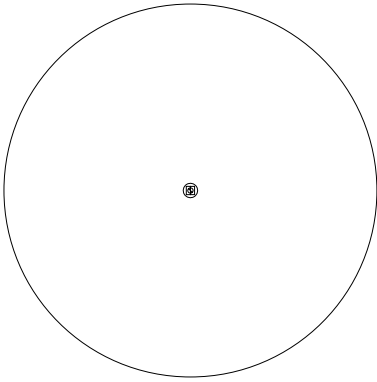

A Tabletop x1



B Column x1

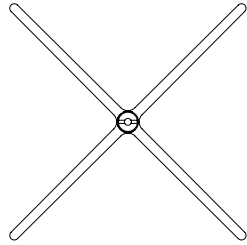

C Base x1



D Screw x1



E Washer x1



F Washer x1



G Allen key x1

Protect the table top from scratches and other damage while assembling.

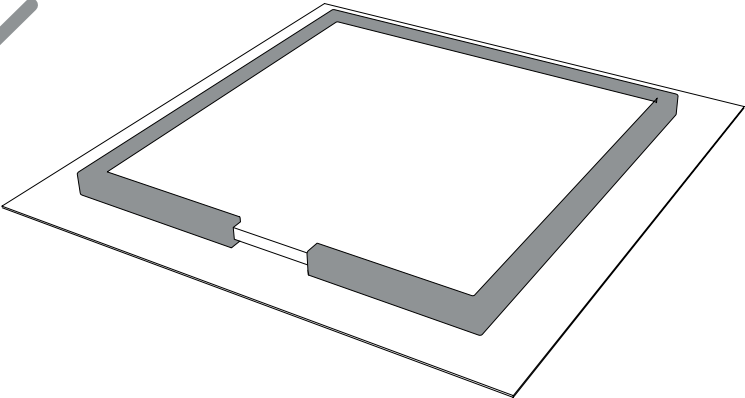
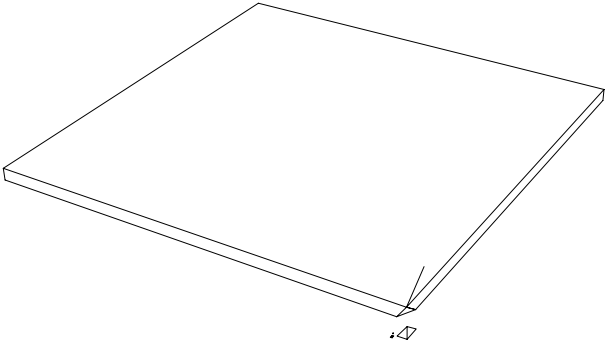

1.

Place the big **E** washer on the tabletop.
Then place part **B** on top of the washer.

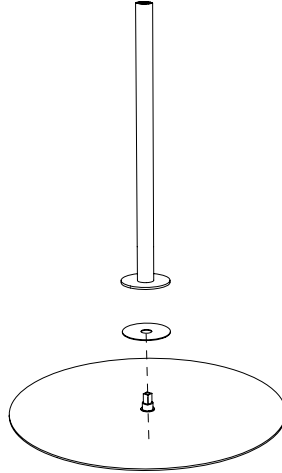

2.

Insert part **C** into part **B**.

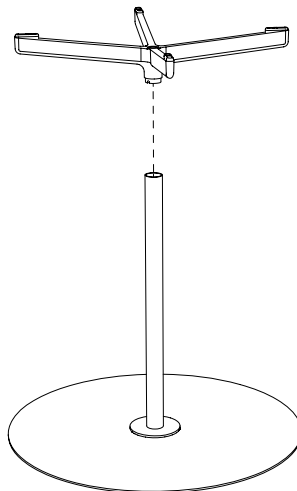

3.

Insert part **D** through the washer **F** and the hole in part **C** and make contact with the threaded part in the tabletop.

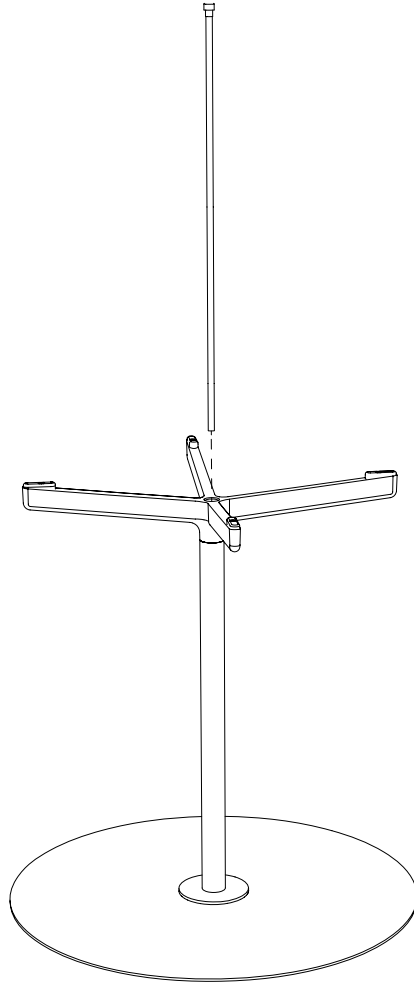

4.

Tighten part **D**.

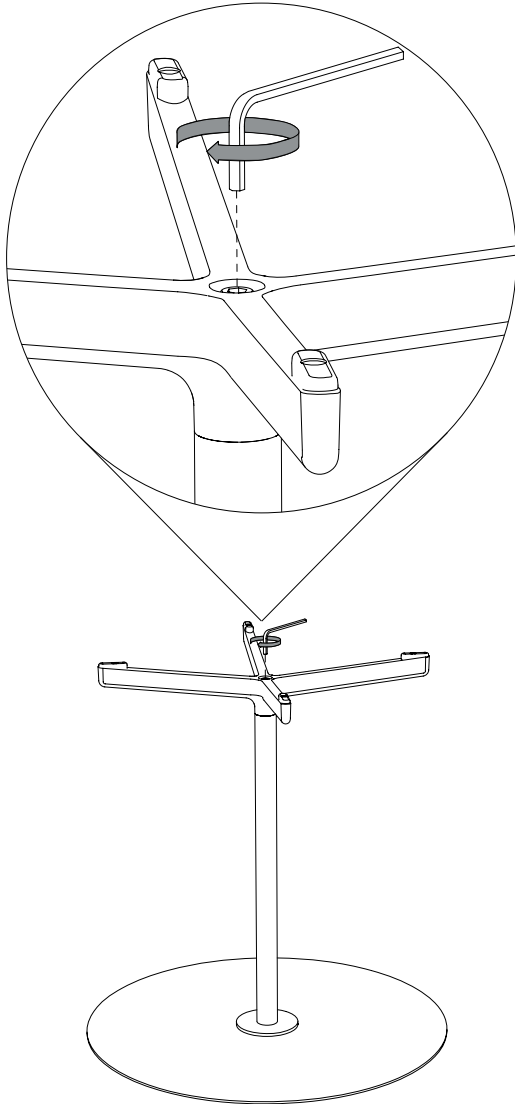

5.

Turn the table over (2 persons recommended).

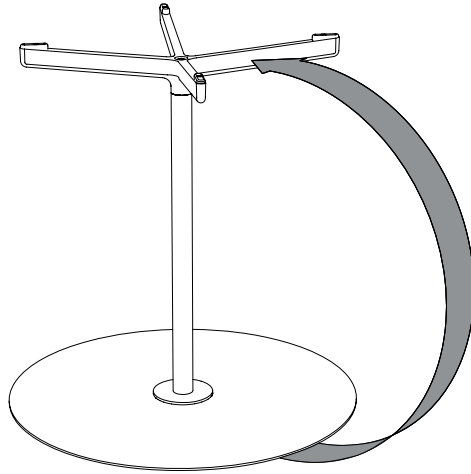

6.

Done!

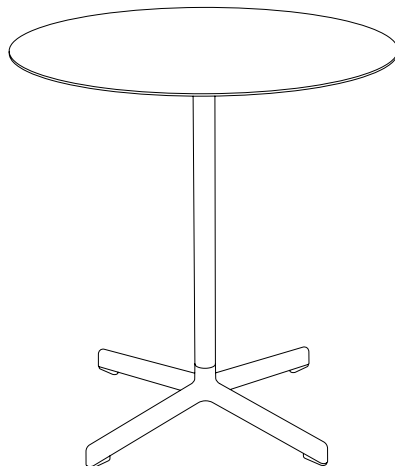

- CARE & MAINTENANCE -

Our Care & Maintenance offers guidance for optimal maintenance of your HAY product. It includes advice and instructions on cleaning and caring for specific materials to prolong the life of your furniture.



Please find our Care & Maintenance guide by scanning the QR code



You can find more relevant information on Neu Table by scanning the QR code

You can also find the same information here
hay.dk/downloads

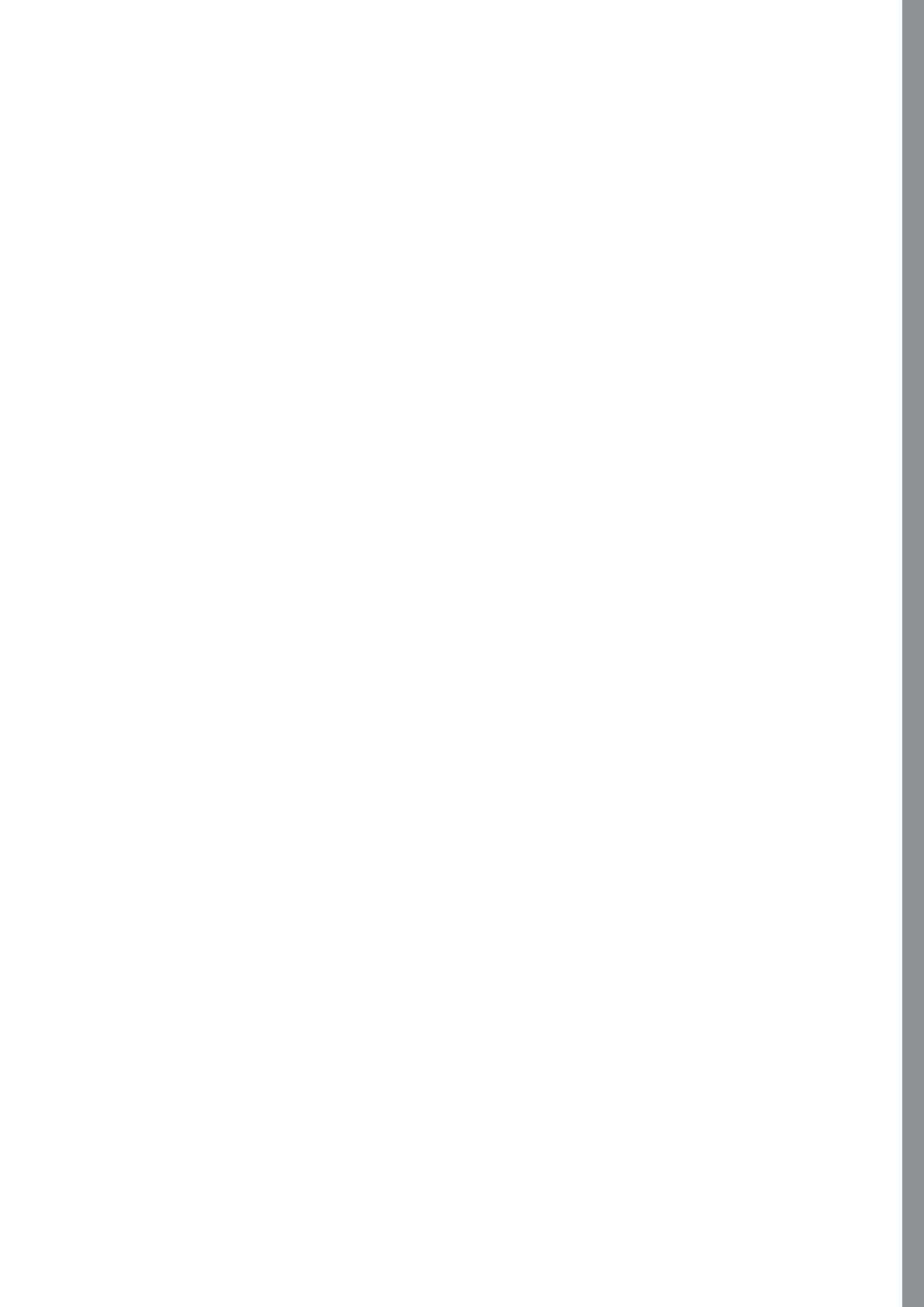

Havnen 1 8700 Horsens Denmark
+45 3164 6000 / hay@hay.com

10/01/2023

HAY